



**A·M·P**<sup>TM</sup>  
PERSONAL AUDIO AMPLIFIER

OPERATIONS MANUAL

**Overview**

Features, Controls and Identification . . . . . 3

**Preparation**

Batteries . . . . . 4

Battery Indicators . . . . . 6

Insertion and Removal . . . . . 8

**Operation**

On & Off . . . . . 9

Volume Control . . . . . 10

Summary of Settings . . . . . 11

**Hearing System Care**

Instrument Care . . . . . 12

Service and Repair . . . . . 12

Troubleshooting Guide . . . . . 13

**Tips for Better Communication**

For You . . . . . 14

For Your Family and Friends . . . . . 15

**FDA Information**

Required Information . . . . . 16

**Features, Controls and Identification****Your hearing system controls include:**

1. Microphone opening

2. Sound outlet (receiver)

3. Battery compartment (on/off control)

4. Removal handle

5. Location of serial number

6. Sleeve

7. AMP wand

a) Power on/off and volume control

b) Optional battery removal tool

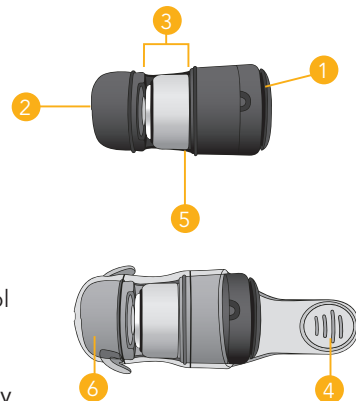

Your hearing system can be identified by the R or L on the device

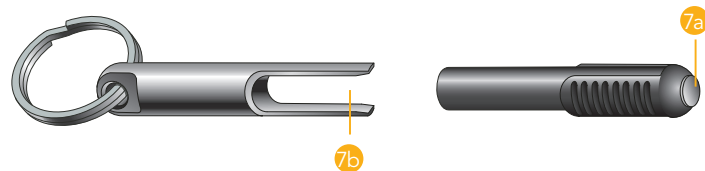

**Batteries**

Your hearing system uses a battery as its power source. This battery size can be identified by the yellow (10) color code on the packaging.

**To insert or replace the battery:**

1. Remove the clear sleeve.
2. Remove old battery using the battery removal tool side of the AMP wand or simply push the battery out from the side with your fingers.
3. Remove the tab from the new battery.
4. Line up the battery's "+" sign (flat side of the battery) with the "+" on the case above the product name.
5. Insert AMP into clear sleeve.

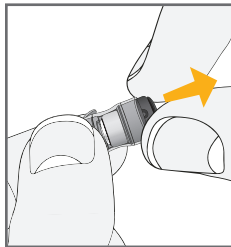

1

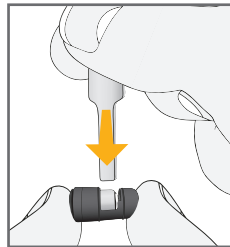

2

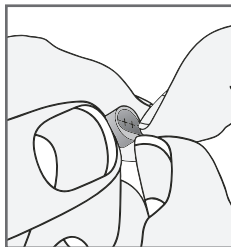

3

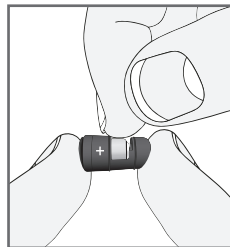

4

**Battery Indicator Tones**

An indicator will sound when the battery voltage is low. You have approximately 5 minutes\* to replace the battery. An indicator will sound just before the battery stops working.

*\* Actual time between low battery indicator and shut down will vary depending on environmental noise levels and brand of battery used.*

**Helpful Hints**

- Because of their size, it's a good idea to change and replace batteries above a table or desk to reduce the risk of dropping the instrument or battery.
- Dispose of used batteries immediately in the proper waste or recycling container.
- Because batteries can vary in size and performance, your hearing care professional is your best source for lifespan estimates and verification that you are using the proper size and type.

**Warnings**

- ⚠ Batteries are dangerous if swallowed. To help prevent the accidental ingestion of batteries:
- ⚠ Keep out of reach of children and pets
- ⚠ Check your medications before taking them – batteries have been mistaken for pills
- ⚠ Never put batteries in your mouth, as they can easily be swallowed
- ⚠ **National Button Battery Ingestion Hotline: 202-625-3333**

**Helpful Hints**

- Minor irritation and inflammation may occur as your ear becomes accustomed to having an object in it; if so, please contact your hearing care professional
- If an actual allergic reaction occurs, contact your hearing care professional
- Severe swelling, discharge from the ear, excessive wax, or other unusual conditions warrant immediate consultation with a physician

**Insertion and Removal****To insert the hearing instrument:**

1. Hold the instrument with your thumb and forefinger grasping the removal handle.
2. Gently insert the canal tip of the instrument into your ear canal. Softly press the instrument into place with your finger.

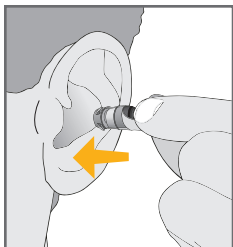

1

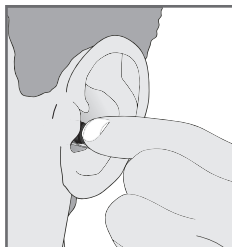

2

**To remove the hearing instrument:**

Grasp the removal handle and gently remove from ear.

**To turn ON:**

Briefly touch and remove the magnetic end of the AMP wand to the front of the hearing device. A tone series indicates that the hearing device is on.

**To turn OFF:**

Briefly touch the magnetic end of the AMP wand to the hearing device. Remove the wand within one second or less. A tone series indicates that the hearing device is off.

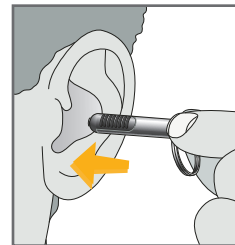

**Volume Control**

To change volume hold the AMP wand on or near the device. When your hearing instruments are powered on the volume adjustment follows a specific pattern. Once powered on, your hearing instruments will adjust in volume the same direction of the last changes you made. Continue holding the wand in place until the volume reaches the desired level.

Depending on how your device is set, you may have up to five volume steps. Your hearing instruments are programmed to beep each time you change the volume.

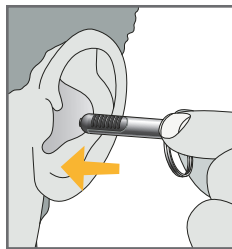

Your hearing system has been set to a specific volume level by your hearing care professional. If sounds are generally too loud or too soft, please contact your hearing care professional for advice and adjustment.

**Volume Settings**

Step	Tone
Up two steps from programmed gain	Five beeps plus tone
Up one step from programmed gain	Four beeps
Programmed gain	Three beeps
Down one step from programmed gain	Two beeps
Down two steps from programmed gain	One beep plus tone

### Instrument Care

Do your best to keep your hearing instrument clean at all times. Heat, moisture and foreign substances can result in poor performance.

- Clean daily over a soft cloth to prevent damage from a fall to a hard surface
- Remove the clear plastic sleeve then use a cleaning brush to clean debris from around the microphone, receiver and the battery compartment
- Never use water, solvents, cleaning fluids or oil to clean your instrument
- The plastic sleeve can be cleaned with soapy water

Your hearing care professional can provide further information on additional maintenance procedures for your hearing system if needed.

### Helpful Hints

- When not in use, remove the batteries completely; place your hearing system in the storage container and store:
  - In a dry, safe place
  - Away from direct sunlight or heat to avoid extreme temperatures
  - Where you can easily find them
  - Safely out of reach of pets and children
- Do not take apart your hearing instruments or insert the cleaning tools inside them

### Service and Repair

If, for any reason, your hearing system does not operate properly, do NOT attempt to fix it yourself. Not only are you likely to violate any applicable warranties or insurance, you could easily cause further damage. Should your hearing system fail or perform poorly, check the guide below for possible solutions. If problems continue, contact your hearing care professional for advice and assistance.

### Troubleshooting Guide

SYMPTOM	POSSIBLE CAUSES	SOLUTIONS
Not Loud Enough	Low battery	Replace battery
	Wax or debris in the microphone or receiver	Clean both microphone and receiver with brush
		Remove and clean the plastic sleeve
	Hearing change	Contact your hearing care professional
Inconsistent Performance	Low battery	Replace battery
Unclear, Distorted Performance	Low battery	Replace battery
	Defective hearing instrument	Contact your hearing care professional
Dead	Low battery	Replace battery
	Wax or debris in the microphone or receiver	Clean both microphone and receiver with brush. Remove and clean the plastic sleeve.

Your hearing care professional will recommend an appropriate schedule to help you adapt to your new hearing system. It will take practice, time and patience for your brain to adapt to the new sounds that your hearing system provides. Hearing is only part of how we share thoughts, ideas and feelings. Reading lips, facial expressions and gestures can help the learning process and add to what amplification alone may miss.

Please review the following simple communication tips:

### For You

- Move closer to and look at the speaker
- Sit face-to-face in a quiet room
- Try different locations to find the best place to listen
- Minimize distractions
- Background noises may be frustrating at first; remember, you have not heard them for a while

- Let others know what you need; keep in mind that people cannot “see” your hearing loss
- Develop realistic expectations of what your hearing instruments can and cannot do
- Better hearing with hearing instruments is a learned skill combining desire, practice and patience

### For Your Family and Friends

Your family and friends are also affected by your hearing loss.

Request that they:

- Get your full attention before beginning to speak
- Look at you or sit face-to-face in a quiet room
- Speak clearly and at a normal rate and level; shouting can actually make understanding more difficult
- Rephrase rather than repeat the same words; different words may be easier to understand
- Minimize distractions while speaking



**Required Information**

The following additional information is provided in compliance with U.S. Food and Drug Administration (FDA) regulations:

**WARNING TO HEARING INSTRUMENT DISPENSERS.** A hearing instrument dispenser should advise a prospective hearing instrument user to consult promptly with a licensed physician (preferably an ear specialist) before dispensing a hearing instrument if the hearing instrument dispenser determines through inquiry, actual observation, or review of any other available information concerning the prospective user, that the prospective user has any of the following conditions:

- i. Visible congenital or traumatic deformity of the ear.
- ii. History of active drainage from the ear within the previous 90 days.
- iii. History of sudden or rapidly progressive hearing loss within the previous 90 days.
- iv. Acute or chronic dizziness.
- v. Unilateral hearing loss of sudden or recent onset within the previous 90 days.
- vi. Audiometric air-bone gap equal to or greater than 15 decibels at 500 Hertz (Hz), 1,000 Hz and 2,000 Hz.
- vii. Visible evidence of significant cerumen accumulation or a foreign body in the ear canal.
- viii. Pain or discomfort in the ear.

Special care should be exercised in selecting and fitting a hearing instrument whose maximum sound pressure level exceeds 132 decibels because there may be risk of impairing the remaining hearing of the hearing instrument user.

**IMPORTANT NOTICE FOR PROSPECTIVE HEARING INSTRUMENT USERS.** Good health practice requires that a person with a hearing loss have a medical evaluation by a licensed physician (preferably a physician who specializes in diseases of the ear) before purchasing a hearing instrument. Licensed physicians who specialize in diseases of the ear are often referred to as otolaryngologists, otologists, or otorhinolaryngologists. The purpose of the medical evaluation is to assure that all medically treatable conditions that may affect hearing are identified and treated before the hearing instrument is purchased.

Following the medical evaluation, the physician will give you a written statement that states that your hearing loss has been medically evaluated and that you may be considered a candidate for a hearing instrument. The physician will refer you to an audiologist or hearing instrument dispenser, as appropriate, for a hearing instrument evaluation.

The audiologist or hearing instrument dispenser will conduct a hearing instrument evaluation to assess your ability to hear with and without a hearing instrument. The hearing instrument evaluation will enable the audiologist or dispenser to select and fit a hearing instrument to your individual needs.

If you have reservations about your ability to adapt to amplification, you should inquire about the availability of a trial-rental or purchase-option program. Many hearing instrument dispensers now offer programs that permit you to wear a hearing instrument for a period of time for a nominal fee after which you may decide if you want to purchase the hearing instrument.

Federal law restricts the sale of hearing instruments to those individuals who have obtained a medical evaluation from a licensed physician. Federal law permits a fully informed adult to sign a waiver statement declining the medical evaluation for religious or personal beliefs that preclude consultation with a physician. The exercise of such a waiver is not in your best health interest and its use is strongly discouraged.

A hearing aid will not restore normal hearing and will not prevent or improve a hearing impairment resulting from organic conditions. Use of a hearing aid is only part of hearing habilitation and may need to be supplemented by auditory training and instruction in lip reading. In most cases infrequent use of a hearing aid does not permit a user to attain full benefit from it.

**CHILDREN WITH HEARING LOSS.** In addition to seeing a physician for a medical evaluation, a child with a hearing loss should be directed to an audiologist for evaluation and rehabilitation since hearing loss may cause problems in language development and the educational and social growth of a child. An audiologist is qualified by training and experience to assist in the evaluation and rehabilitation of a child with a hearing loss.

**LIMITED WARRANTY:**

This Limited Warranty provided by Starkey Laboratories, Inc. ("Starkey"), to you, the original purchaser of a Starkey hearing instrument, covers your new hearing instrument when sold by a hearing professional authorized by Starkey. The duration of this Limited Warranty begins when you first take delivery of your hearing instrument from an authorized hearing professional and ends twelve (12) months later ("warranty period").

**LIMITATION ON DURATION OF IMPLIED WARRANTIES:**

IMPLIED WARRANTIES, IF ANY, ARISING BY WAY OF STATE LAW, INCLUDING ANY IMPLIED WARRANTY OF MERCHANTABILITY AND/OR ANY IMPLIED WARRANTY OF FITNESS FOR A PARTICULAR PURPOSE, ARE LIMITED IN DURATION TO THE WARRANTY PERIOD.

There is no warranty of any nature made by Starkey beyond this Limited Warranty. No person has authority to enlarge, amend, or modify this Limited Warranty. Starkey is not responsible for any undertaking, representation, or warranty (written, express, or implied) made by any hearing professional or other person beyond those expressly set forth in this Limited Warranty.

Some States do not allow limitations on how long an implied warranty lasts, so the above limitation may not apply to you.

**WHAT THIS LIMITED WARRANTY COVERS:**

This Limited Warranty covers only a "defect" in the workmanship performed and/or materials used to manufacture your hearing instrument. "Defect" means the failure of the workmanship performed and/or materials used to conform the hearing instrument to Starkey's design and manufacturing specifications and tolerances.

Your hearing professional may have issued a warranty or service plan that goes beyond the provisions of this Limited Warranty. Please contact him or her for further information.

Starkey will either replace the hearing instrument or repair any covered defect in your hearing instrument, provided that you deliver your hearing instrument to one of Starkey's authorized hearing professionals and notify the hearing professional of the defect during the warranty period and within thirty (30) days of discovering the defect. There will be no cost to you for Starkey's repair or replacement of the instrument itself, but the hearing professional may charge a fee for services he or she provides. Performance of warranty repairs on your hearing instrument shall not extend the duration of the warranty period. Any repairs performed on your hearing instrument after the warranty period has expired shall be considered "good will" repairs, which shall not alter the terms of this Limited Warranty.

**HOW TO OBTAIN WARRANTY SERVICE:**

Deliver your hearing instrument (at your expense) to the Starkey authorized hearing professional from whom you purchased it. If that professional is unavailable, visit [www.starkey.com](http://www.starkey.com) or call the toll-free telephone number on the back of the Operations Manual to locate another authorized Starkey hearing professional.

**WHAT THIS LIMITED WARRANTY DOES NOT COVER:**

Batteries, earmolds, accessories, or damage to your hearing instrument caused by misuse or neglect, accident, unauthorized alteration, or failure to provide reasonable and necessary maintenance and cleaning.

**DISCLAIMER OF CONSEQUENTIAL AND INCIDENTAL DAMAGES:**

THE PURCHASER SHALL NOT BE ENTITLED TO RECOVER FROM STARKEY ANY CONSEQUENTIAL OR INCIDENTAL DAMAGES RESULTING FROM ANY DEFECT IN THE HEARING INSTRUMENT, INCLUDING BY WAY OF EXAMPLE ONLY, EXPENSES TO DELIVER THE HEARING INSTRUMENT TO AN AUTHORIZED HEARING PROFESSIONAL, HOTEL ROOMS, OR LOST WAGES. THIS EXCLUSION AND DISCLAIMER OF CONSEQUENTIAL AND INCIDENTAL DAMAGES SHALL BE DEEMED INDEPENDENT OF, AND SHALL SURVIVE, ANY FAILURE OF THE ESSENTIAL PURPOSE OF ANY REMEDY OF THIS LIMITED WARRANTY.

Some States do not allow the exclusion or limitation of consequential or incidental damages, so the above exclusions may not apply to you.

**YOUR LEGAL REMEDIES:**

THIS LIMITED WARRANTY DOES NOT "EXTEND TO FUTURE PERFORMANCE." ANY ACTION TO ENFORCE THIS LIMITED WARRANTY OR ANY IMPLIED WARRANTIES MAY AND SHALL NOT BE COMMENCED MORE THAN 90 DAYS AFTER THE EXPIRATION OF THE WARRANTY PERIOD. THE PERFORMANCE OF REPAIRS SHALL NOT SUSPEND THIS LIMITATIONS PERIOD FROM EXPIRING. UNDER NO CIRCUMSTANCES SHALL STARKEY BE OBLIGATED TO REFUND ALL OR ANY PART OF THE PURCHASE PRICE OF THE HEARING INSTRUMENT. Some States do not allow the reduction in the limitation period, so the above reduction in the limitation period may not apply to you.

This warranty gives you specific legal rights. You may also have other rights which vary from State to State.

This warranty is valid only in the United States.

Starkey World Headquarters  
6700 Washington Avenue South  
Eden Prairie, MN 55344



Wm. F. Austin House, Bramhall Technology Park  
Pepper Road, Hazel Grove, Stockport SK7 5BX  
United Kingdom  
[www.starkey.com](http://www.starkey.com)



6700 Washington Avenue South  
Eden Prairie, MN 55344-3476  
800.328.8602

© 2011 All Rights Reserved

84689-007 6/11 BKLT0226-01-EE-XX Rev. B

CE  
0086